

The Application of Telecoms-Style Packaging Techniques to Narrow Linewidth Laser Modules for Quantum Technologies

W. Dorward^{*a}, S. T. Lee^a, D. Bremner^a, S. Robertson^a, B. Jones^b, C. Carson^b, L. McKnight^b.

^aOptocap Ltd, 5 Bain Square, Kirkton Campus, Livingston, UK, EH54 7DQ; ^bFraunhofer Centre for Applied Photonics, Level 5, Technology and Innovation Centre (TIC), 99 George Street, Glasgow, UK, G1 1RD.

ABSTRACT

Quantum Technologies (QT) hold the promise of a step-change improvement in many high-impact applications, such as ultra-stable clocks and extremely sensitive gravity & acceleration sensors for financial transaction timestamping, satellite-free navigation, oil & gas prospecting, land-surveying, secure communications and scientific research. The underpinning scientific principles of QT systems are largely developed, but for QT to fulfil its potential then orders of magnitude reduction in size, cost and power consumption of the enabling technologies is required. Stabilized laser systems are key ingredients of many quantum sensors. In many cases multiple lasers, each with specific wavelength, power and linewidth requirements, are needed for cooling, trapping, imaging and the clock references. In this paper we describe the design and packaging of a compact, frequency-stabilized 780nm laser module with integrated vapor reference cell. This stabilized source addresses the D2 transition of 87Rb that connects the ground and excited states, which is used for laser cooling, trapping and repumping in a rubidium interferometer. Component packaging techniques more normally employed in telecoms component packaging are utilized to minimize size and maximize stability. The resulting laser module lends itself to usage in applications in portable instruments outside of the lab.

Keywords: stabilized laser, telecoms packaging, quantum technologies, miniaturization, laser cooling..

1. INTRODUCTION

Narrow linewidth lasers are a key enabling technology in application areas as diverse as holography, remote sensing, spectroscopy and Quantum Technologies (QT). In the QT area alone, these sources are at the heart of systems that hold the promise of a step-change improvement in many high-impact applications, such as ultra-stable clocks¹ for financial transaction timestamping, extremely sensitive gravity² & acceleration sensors, satellite-free navigation³, oil & gas prospecting, land-surveying, secure communications and scientific research.

The underpinning scientific principles of QT systems are largely developed, but for QT to fulfil its potential then orders of magnitude reduction in size, cost and power consumption of the enabling technologies is required. As QT applications emerge from the laboratory and confront the challenging size, weight, power, cost and reliability demands of the real-world, there is a growing requirement for a new generation of compact, stable and reliable lasers narrow linewidth lasers.

In this paper we will describe recent developments in two approaches to the design and packaging of compact, narrow-linewidth 780nm laser sources. This wavelength addresses the D2 transition of 87Rb⁴ that connects the ground and excited states, which is used for laser cooling, trapping and repumping in a rubidium interferometer². Component packaging techniques more normally employed in telecoms component packaging are utilized to minimize size and maximize stability. The resulting laser modules lend themselves to usage in applications in portable instruments outside of the lab.

*William.dorward@optocap.com; phone +44 (0)1506 403 572; fax +44 (0)1506 403 551; optocap.com

2. FLAME: A COMPACT, FREQUENCY-STABILIZED LASER MODULE

Distributed Feedback (DFB) lasers and Distributed Bragg Reflector (DBR) lasers⁵ are compact and robust semiconductor lasers that deliver sub-MHz linewidth outputs suitable for applications such as laser cooling. However a free-running narrow-linewidth laser on its own is not sufficient for many applications and the wavelength of the laser must be stabilized to a reference. The FLAME laser described here takes these narrow linewidth sources and packages them in a frequency-stabilized module by integrating a vapor cell that allows locking to spectral features of an atomic reference. This first FLAME demonstration addresses transitions of Rubidium around 780 nm that are key to applications in Quantum Technologies. The system will be extended in the future to other wavelengths where appropriate lasers and atomic standards are available, such as Cesium at 852nm.

A schematic layout of the FLAME system is shown in figure 1. A small fraction of the output of the laser source is split off and used to provide the necessary feedback for frequency stabilisation. The architecture used allows for double-pass saturated-absorption spectroscopy⁶ when the output wavelength of the laser source is tuned. This tuning is provided through temperature tuning of the laser using a thermo-electric cooler (TEC) and by tuning the drive current of the laser source itself.

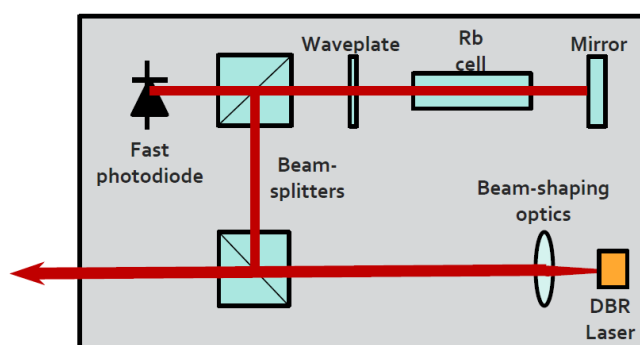

Figure 1: Schematic of the FLAME laser architecture, showing the optical arrangement for double-pass saturated absorption spectroscopy in the Rubidium gas cell.

The FLAME system itself is shown with its lid removed in figure 2. The packaging methods employed are selected from telecoms and space-qualified processes to ensure stability and reliability. Cleanliness and low-outgassing of components is ensured via the use of gold-coated metal components, flux-free soldering, low-outgassing space-qualified adhesives and proven cleaning techniques throughout. Production time is minimised while maximising repeatability via automated wirebonding and by utilising pick and place alignment of the majority of components. The module is configured with a beam-expander telescope to reduce output beam divergence and allows for heating of the integrated Rubidium cell for improved wavelength locking.

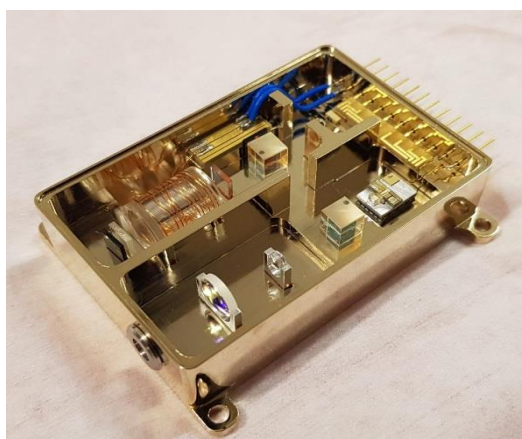

Figure 2: The FLAME laser with lid removed.

Linewidth measurements of the laser were carried out by analyzing the error signal produced while locked. The lock-point chosen on the atomic spectrum is shown in figure 3.

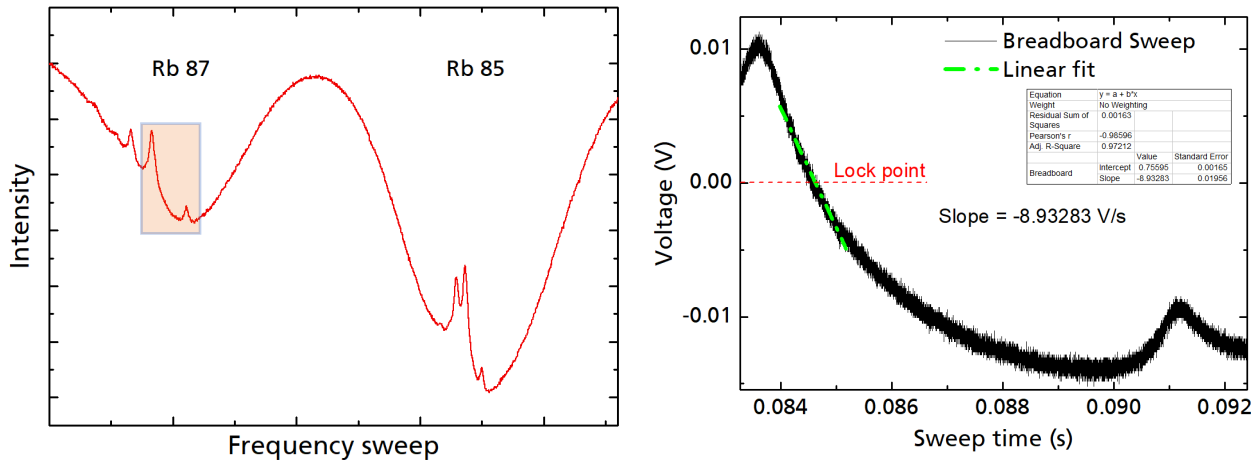

Figure 3: Rubidium spectrum with chosen locking area for side-of-fringe locking to Rb-87 indicated and a plot of a close-up of the laser sweep over the Rb-87 crossover transition with lock-point illustrated.

Once locked, the error signal allows for the monitoring of frequency fluctuation via the intensity fluctuations on the photodiode as the frequency moves up and down the spectral feature. This feature is used to map the noise seen in the voltage when locked into frequency, via a sweep with a known frequency length. In this case, we use the peaks of a 1.5 GHz free-spectral-range Fabry-Perot interferometer to calibrate the sweep-time axis (to give Hz/s), and then use that with the V/s fit slope shown in 3 to give V/Hz .

Figure 4 shows the resultant power-spectral-density (PSD) measurements and their associated linewidths both for side-of-fringe locking and for locking to the crossover peak using a 250kHz laser-drive current modulation. These measurements were completed on early FLAME prototypes. Integrating this data from 20Hz to 5MHz results in linewidths of 640kHz for peak locking and 220kHz for side-of-fringe locking.

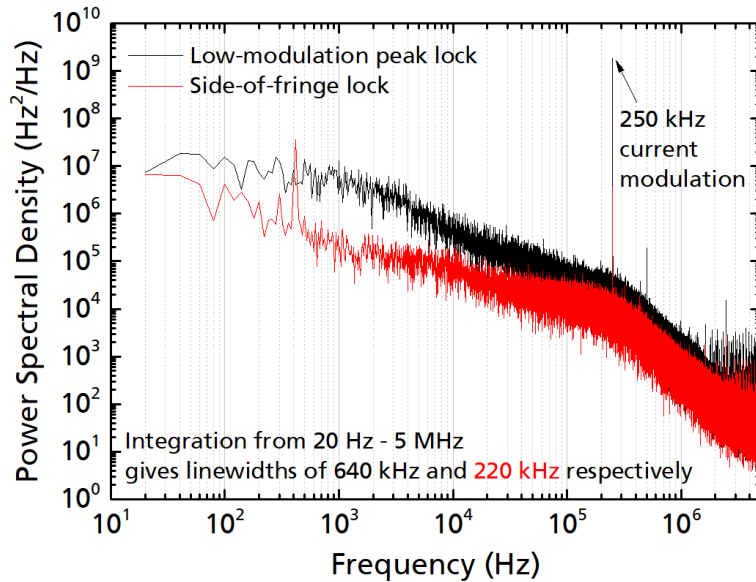

Figure 4: PSD measurements of a FLAME prototype using two different locking methods. Peak locking resulted in a linewidth of 640kHz while side-of-fringe locking achieved 220kHz, integrated from 20Hz to 5MHz.

Further work on the FLAME laser will target minimizing linewidth via the optimization of locking techniques and development of custom drive electronics, the integration of further functionality such as fiber-coupling and optical isolation, and operation at other wavelengths of interest.

3. REMOTE MICRO-ECDL

External cavity diode lasers (ECDLs) are commonly used as narrow linewidth sources for QT experiments. An ECDL utilizes a simple laser diode that would normally produce a relatively large linewidth output and then narrows that linewidth down to $<500\text{kHz}$ by frequency-selective feedback from an external laser resonator. In contrast to DFB and DBR lasers, the ECDL is larger and has the potential for misalignment issues. On the other hand, the ECDL can utilize a wide range of commercially available laser diodes, offering the potential for higher power and more wavelength flexibility, and has the potential to produce narrower linewidths than monolithic semiconductor designs can achieve. The ECDL can be a complimentary source to DFB and DBR lasers if it can be packaged in a compact and robust manner appropriate to the application.

The REMOTE external-cavity diode laser (ECDL) is a butterfly-packaged micro-ECDL⁷. Figure 5(a) shows a plan-view of the ECDL built up within a butterfly package, while figures 5(b) & (c) illustrate schematically the ECDL optical components.

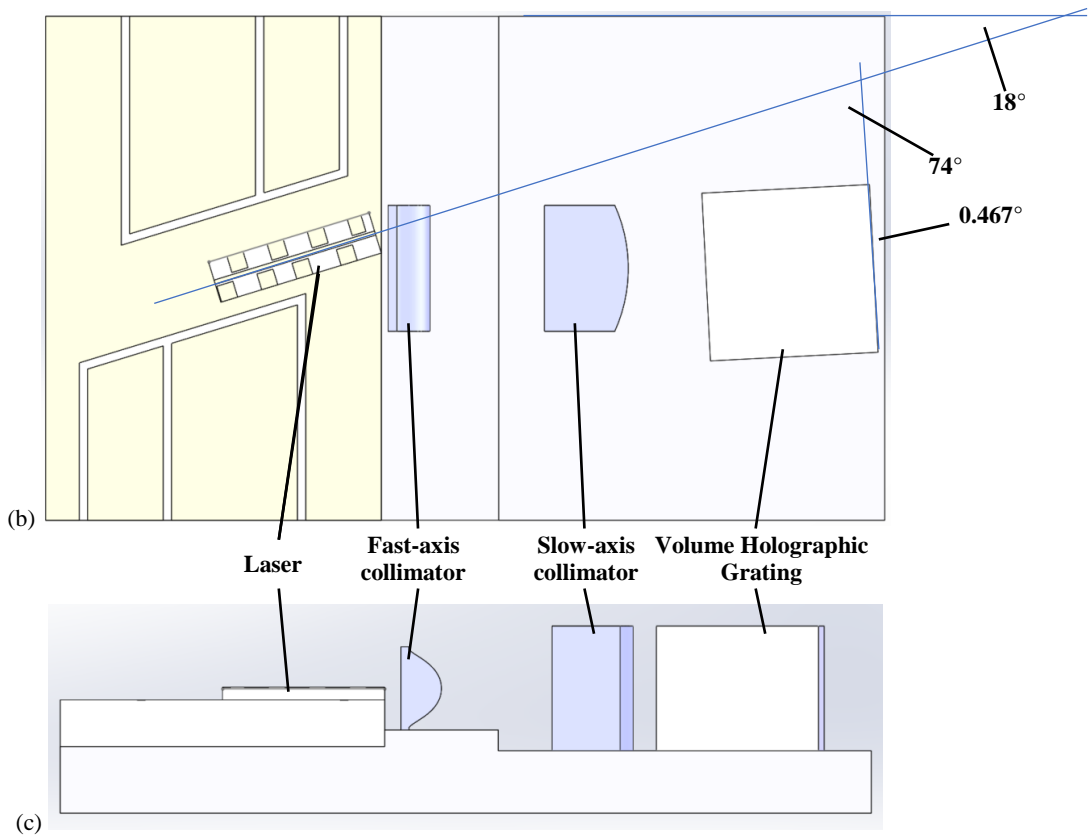
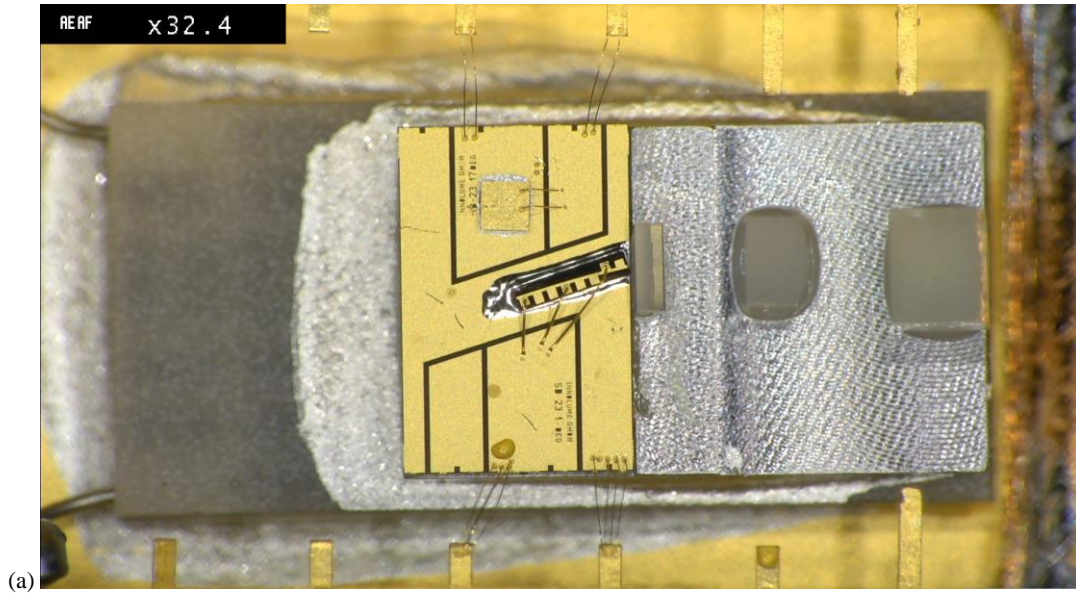

Figure 5. REMOTE Micro-ECDL. (a) Assembled unit without package lid. (b) Plan-view of optical architecture with angles as measured on assembled unit. (c) Side-view of optical architecture.

The REMOTE prototype was then locked to an external spectroscopy setup, as shown in figure 6. This arrangement mimics that used in section 2 within the FLAME module. With the laser stabilized, single-frequency operation was confirmed with a Fabry-Perot interferometer.

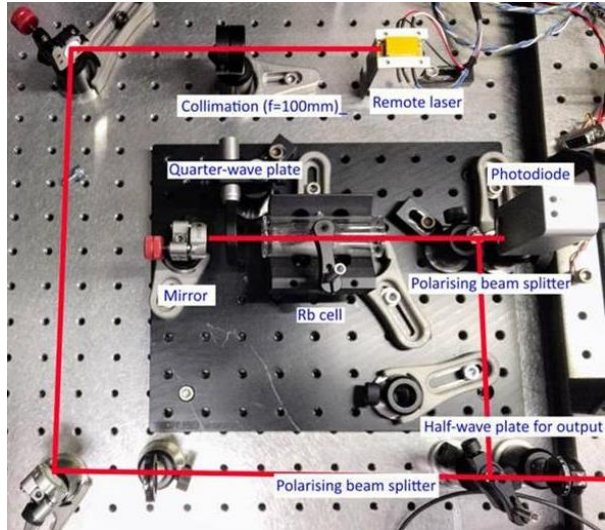

Figure 6. Breadboard setup for stabilization of the REMOTE prototype to a Rubidium reference.

With changing current, the laser will mode-hop and lose its single-frequency operation, however adjusting the temperature of the package will move the position of the mode-hop allowing the wavelength of interest to occur in a stable region. Figure 7 shows absorption (blue) and transmission (red) spectra obtained with the setup in figure 6. The position of the mode-hops has been tuned so that they occur outside the region of interest. Figure 7 shows that output of the REMOTE laser can address the whole of the Rb-87 and Rb-85 spectrum of interest. This corresponds to ~4 GHz mode-hop-free tuning range with current alone.

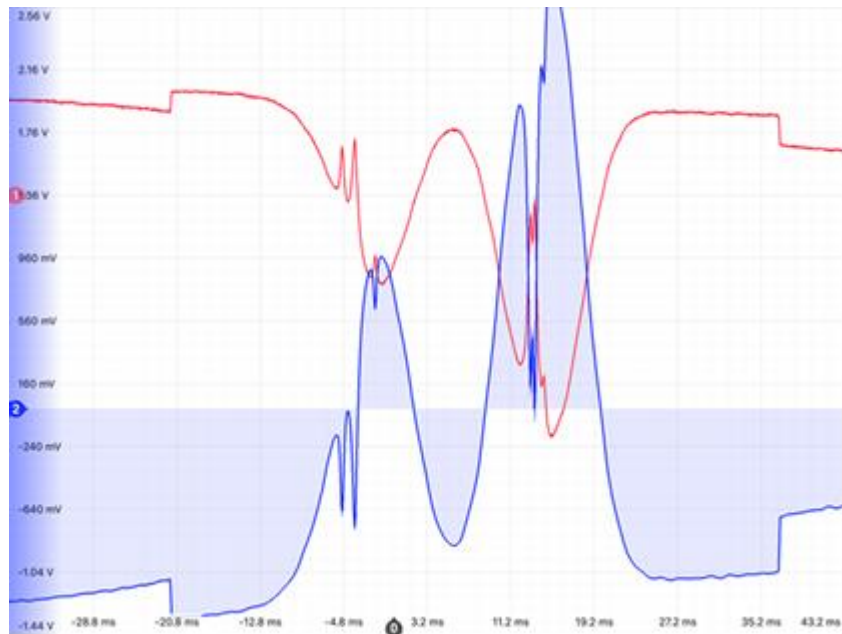

Figure 7. Absorption (blue) and transmission (red) spectra of Rb-87 and Rb-85 obtained with the setup of figure 6. Mode-hops are visible as steps in the wings on either side of the spectra.

The REMOTE laser was locked to the crossover peak of Rb-87 and coupled into a fiber with the output from another laser whose linewidth is significantly narrower than that expected from the REMOTE. This second laser was detuned by ~10MHz from the REMOTE. A beat-note measurement of this combination gives a combined FWHM linewidth of 400kHz for a 2ms measurement. Discounting the other laser's linewidth gives a worst-case linewidth for the REMOTE prototype of 400kHz. Figure 8 shows a fast Fourier transform of that beat-note.

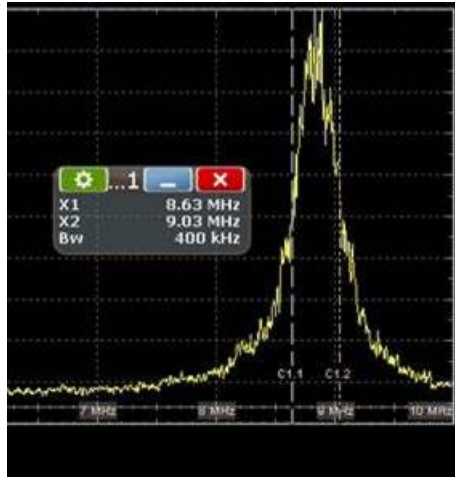

Figure 8. Fast Fourier Transform of the beatnote between a REMOTE and a narrower linewidth laser. The linewidth of 400kHz represents an upper limit on the actual linewidth of the REMOTE laser.

Further work on the REMOTE laser will further characterize the system and explore the tradeoffs of using one or more TECs for individual temperature control of the key resonator building-blocks. Investigations of power-scaling, linewidth minimization and extension to other key wavelengths of interest are underway.

4. CONCLUSIONS

We have demonstrated two narrow-linewidth laser modules, FLAME and REMOTE, suitable for application in QT and other applications. Engineering work to package the systems in a compact and robust format is underway. The FLAME system is at production prototype stage and is currently undergoing further characterization and manufacturing process development to make ready for an imminent product launch. The REMOTE is at a somewhat earlier prototyping stage and will follow a similar path towards production readiness over the coming months.

REFERENCES

- [1] Takamoto, M., Hong, F.-L., Higashi, R. and Katori, H., "An optical lattice clock." *Nature* 435, p321 (2005).
- [2] Peters, A., Chung, K. Y. and Chu, S., "High-precision gravity measurements using atom interferometry." *Metrologia* 38, p25 (2001).
- [3] Geiger, R., Ménotret, V., Stern, G., Zahzam, N., Cheinet, P., Battelier, B., Villing, A., Moron, F., Lours, M., Bidet, Y. and Bresson, A., "Detecting inertial effects with airborne matter-wave interferometry." *Nature communications*, 2, p.474 (2011).
- [4] Steck, D. A., "Rubidium 87 D line data," (2001), <http://steck.us/alkalidata>.
- [5] Buus, J., Amann, M. C., and Blumenthal, D. J., "Tunable laser diodes and related optical sources," pp. 79-106. New York: Wiley-Interscience (2006).
- [6] Preston, D.W., "Doppler-free saturated absorption: Laser spectroscopy," *American Journal of Physics*, 64(11), pp.1432-1436 (1996).
- [7] Hieta, T., Vainio, M., Moser, C. and Ikonen, E., "External-cavity lasers based on a volume holographic grating at normal incidence for spectroscopy in the visible range," *Optics Communications* 282(15), pp.3119-3123 (2009).